

Write your name here

Surname	Other names
---------	-------------

Pearson Edexcel
Level 1 / Level 2
GCSE (9–1)

Centre Number

--	--	--	--	--

Candidate Number

--	--	--	--

Mathematics

Paper 2 (Calculator)

Higher Tier

Thursday 8 June 2017 – Morning

Time: 1 hour 30 minutes

Paper Reference

1MA1/2H

You must have: Ruler graduated in centimetres and millimetres, protractor, pair of compasses, pen, HB pencil, eraser, calculator. Tracing paper may be used.

Total Marks

Instructions

- Use **black** ink or ball-point pen.
- **Fill in the boxes** at the top of this page with your name, centre number and candidate number.
- Answer **all** questions.
- Answer the questions in the spaces provided – *there may be more space than you need.*
- You must **show all your working**.
- Diagrams are **NOT** accurately drawn, unless otherwise indicated.
- **Calculators may be used.**
- If your calculator does not have a π button, take the value of π to be 3.142 unless the question instructs otherwise.



Information

- The total mark for this paper is 80.
- The marks for **each** question are shown in brackets – *use this as a guide as to how much time to spend on each question.*

Advice

- Read each question carefully before you start to answer it.
- Keep an eye on the time.
- Try to answer every question.
- Check your answers if you have time at the end.

Turn over ►

P48148RA

©2017 Pearson Education Ltd.

6/6/6/6/7/1/



P 4 8 1 4 8 R A 0 1 2 4



Pearson

Answer ALL questions.

Write your answers in the spaces provided.

You must write down all the stages in your working.

- 1 The table shows the probabilities that a biased dice will land on 2, on 3, on 4, on 5 and on 6

Number on dice	1	2	3	4	5	6
Probability		0.17	0.18	0.09	0.15	0.1

Neymar rolls the biased dice 200 times.

Work out an estimate for the total number of times the dice will land on 1 or on 3

.....
(Total for Question 1 is 3 marks)

DO NOT WRITE IN THIS AREA

DO NOT WRITE IN THIS AREA

DO NOT WRITE IN THIS AREA



DO NOT WRITE IN THIS AREA

DO NOT WRITE IN THIS AREA

DO NOT WRITE IN THIS AREA

- 2 On Saturday, some adults and some children were in a theatre.
The ratio of the number of adults to the number of children was 5 : 2

Each person had a seat in the Circle or had a seat in the Stalls.

$\frac{3}{4}$ of the children had seats in the Stalls.

117 children had seats in the Circle.

There are exactly 2600 seats in the theatre.

On this Saturday, were there people on more than 60% of the seats?
You must show how you get your answer.

(Total for Question 2 is 5 marks)



3 The diagram shows a prism with a cross section in the shape of a trapezium.

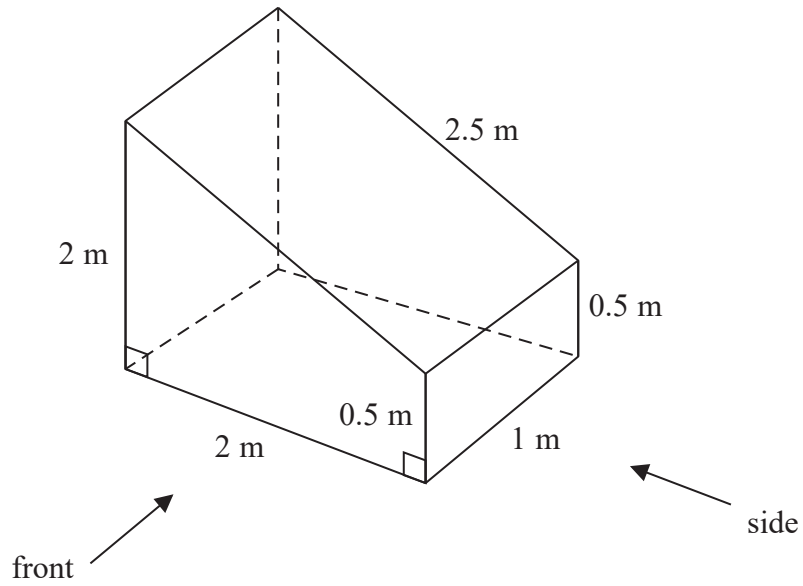

On the centimetre grid below, draw the front elevation and the side elevation of the prism. Use a scale of 2 cm to 1 m.

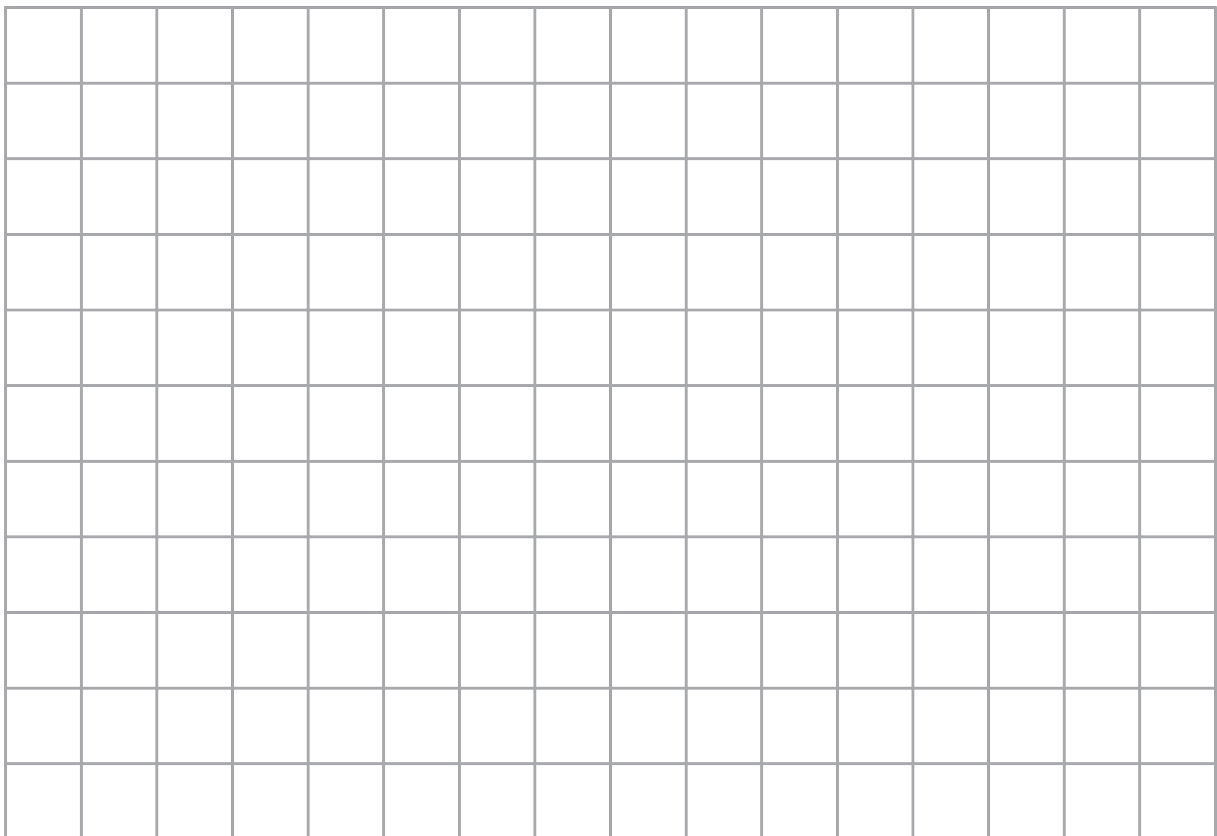

(Total for Question 3 is 4 marks)

DO NOT WRITE IN THIS AREA

DO NOT WRITE IN THIS AREA

DO NOT WRITE IN THIS AREA



DO NOT WRITE IN THIS AREA

DO NOT WRITE IN THIS AREA

DO NOT WRITE IN THIS AREA

- 4 Olly drove 56 km from Liverpool to Manchester.
He then drove 61 km from Manchester to Sheffield.

Olly's average speed from Liverpool to Manchester was 70 km/h.
Olly took 75 minutes to drive from Manchester to Sheffield.

- (a) Work out Olly's average speed for his total drive from Liverpool to Sheffield.

..... km/h
(4)

Janie drove from Barnsley to York.

Janie's average speed from Barnsley to Leeds was 80 km/h.
Her average speed from Leeds to York was 60 km/h.

Janie says that the average speed from Barnsley to York can be found by working out the mean of 80 km/h and 60 km/h.

- (b) If Janie is correct, what does this tell you about the two parts of Janie's journey?

.....
.....
(1)

(Total for Question 4 is 5 marks)



5

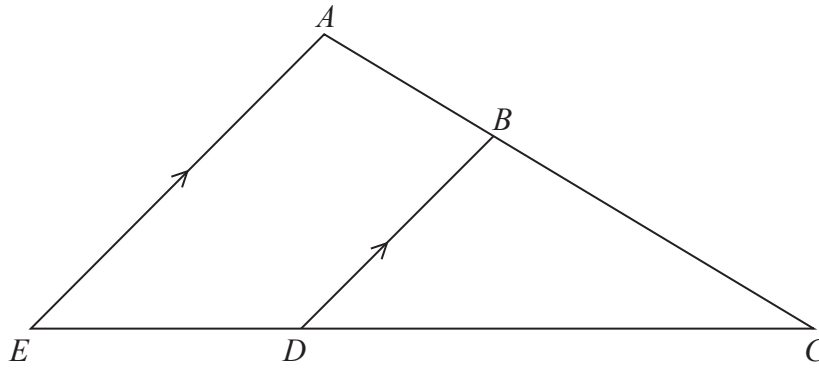

ABC and EDC are straight lines.
 EA is parallel to DB .

- $EC = 8.1$ cm.
- $DC = 5.4$ cm.
- $DB = 2.6$ cm.

(a) Work out the length of AE .

..... cm
 (2)

$AC = 6.15$ cm.

(b) Work out the length of AB .

..... cm
 (2)

(Total for Question 5 is 4 marks)

6



DO NOT WRITE IN THIS AREA

DO NOT WRITE IN THIS AREA

DO NOT WRITE IN THIS AREA

- 6 Anil wants to invest £25 000 for 3 years in a bank.

Personal Bank

Compound Interest

2% for each year

Secure Bank

Compound Interest

4.3% for the first year
0.9% for each extra year

Which bank will give Anil the most interest at the end of 3 years?
You must show all your working.

(Total for Question 6 is 3 marks)

- 7 A number, n , is rounded to 2 decimal places.
The result is 4.76

Using inequalities, write down the error interval for n .

(Total for Question 7 is 2 marks)



- 8 The cumulative frequency graph shows some information about the heights, in cm, of 60 students.

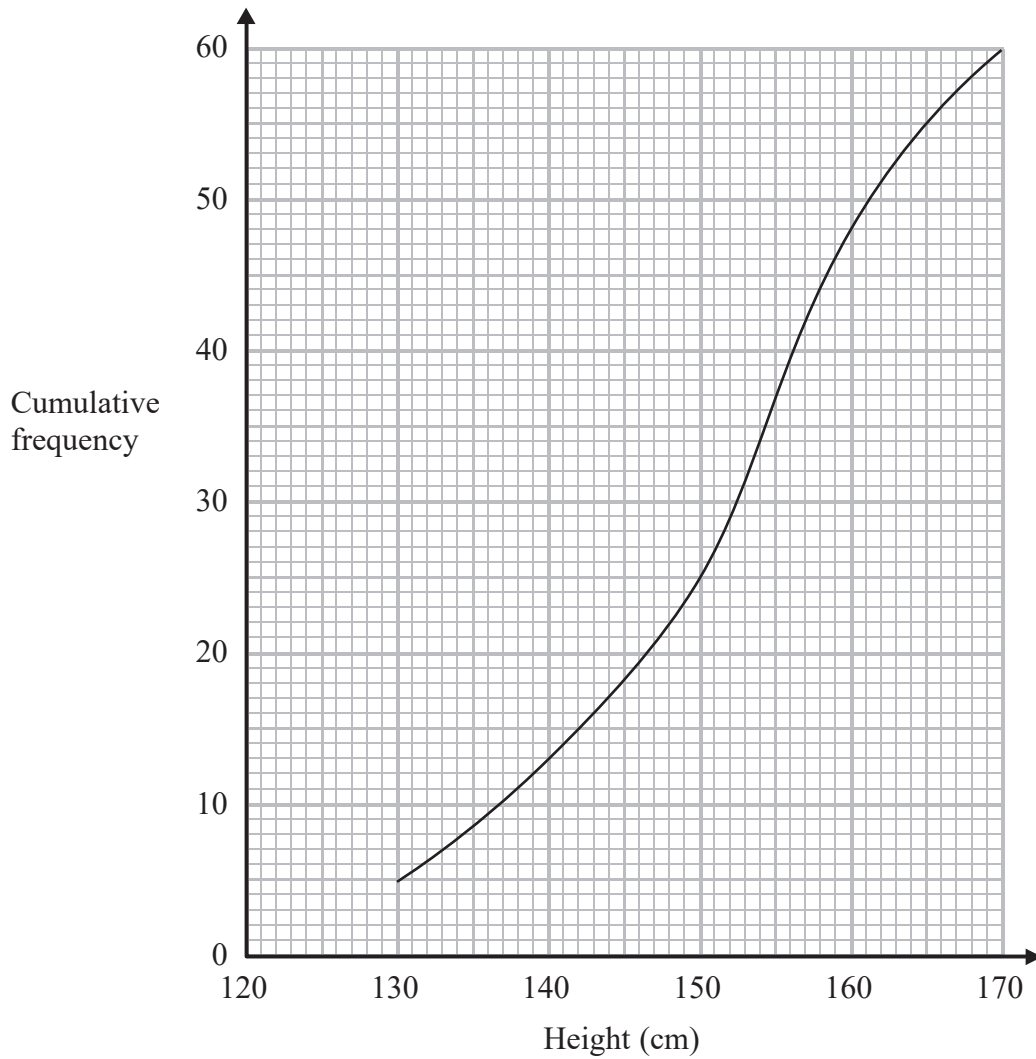

Work out an estimate for the number of these students with a height greater than 160 cm.

(Total for Question 8 is 2 marks)

DO NOT WRITE IN THIS AREA

DO NOT WRITE IN THIS AREA

DO NOT WRITE IN THIS AREA



- 9 The diagram shows triangle **A** drawn on a grid.

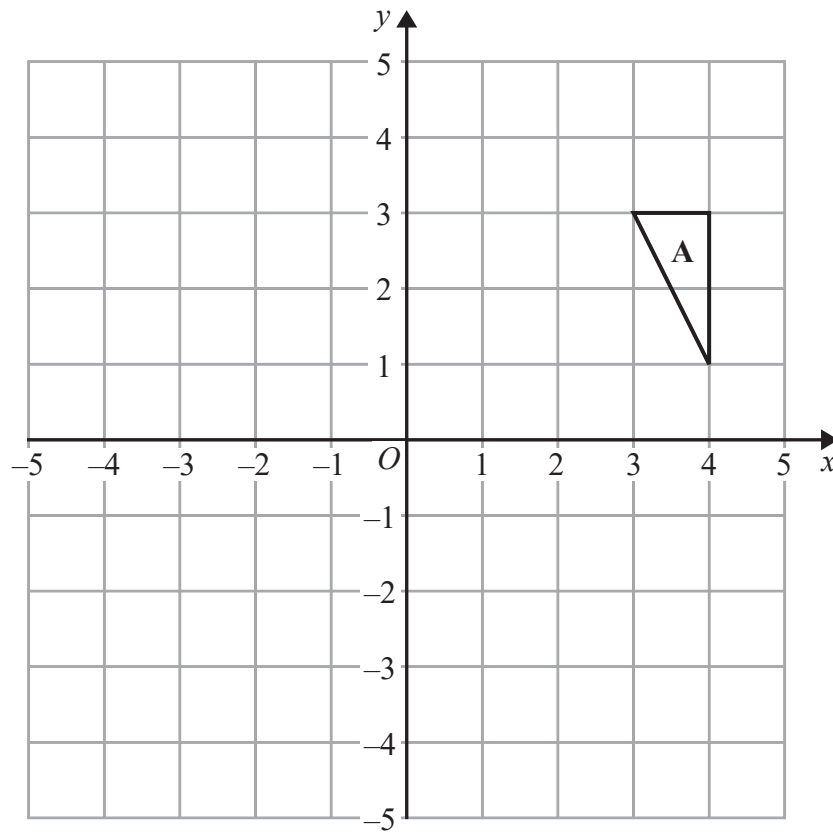

Kyle reflects triangle **A** in the x -axis to get triangle **B**.
He then reflects triangle **B** in the line $y = x$ to get triangle **C**.

Amy reflects triangle **A** in the line $y = x$ to get triangle **D**.
She is then going to reflect triangle **D** in the x -axis to get triangle **E**.

Amy says that triangle **E** should be in the same position as triangle **C**.

Is Amy correct?
You must show how you get your answer.

(Total for Question 9 is 3 marks)



10 The table shows some information about eight planets.

Planet	Distance from Earth (km)	Mass (kg)
Earth	0	5.97×10^{24}
Jupiter	6.29×10^8	1.898×10^{27}
Mars	7.83×10^7	6.42×10^{23}
Mercury	9.17×10^7	3.302×10^{23}
Neptune	4.35×10^9	1.024×10^{26}
Saturn	1.28×10^9	5.68×10^{26}
Uranus	2.72×10^9	8.683×10^{25}
Venus	4.14×10^7	4.869×10^{24}

(a) Write down the name of the planet with the greatest mass.

.....
(1)

(b) Find the difference between the mass of Venus and the mass of Mercury.

..... kg
(1)

Nishat says that Neptune is over a hundred times further away from Earth than Venus is.

(c) Is Nishat right?

You must show how you get your answer.

(2)

(Total for Question 10 is 4 marks)

DO NOT WRITE IN THIS AREA

DO NOT WRITE IN THIS AREA

DO NOT WRITE IN THIS AREA



11 Solve $\frac{3x - 2}{4} - \frac{2x + 5}{3} = \frac{1 - x}{6}$

$x = \dots\dots\dots$

(Total for Question 11 is 4 marks)

DO NOT WRITE IN THIS AREA

DO NOT WRITE IN THIS AREA

DO NOT WRITE IN THIS AREA



13 The histogram shows some information about the ages of the 134 members of a sports club.

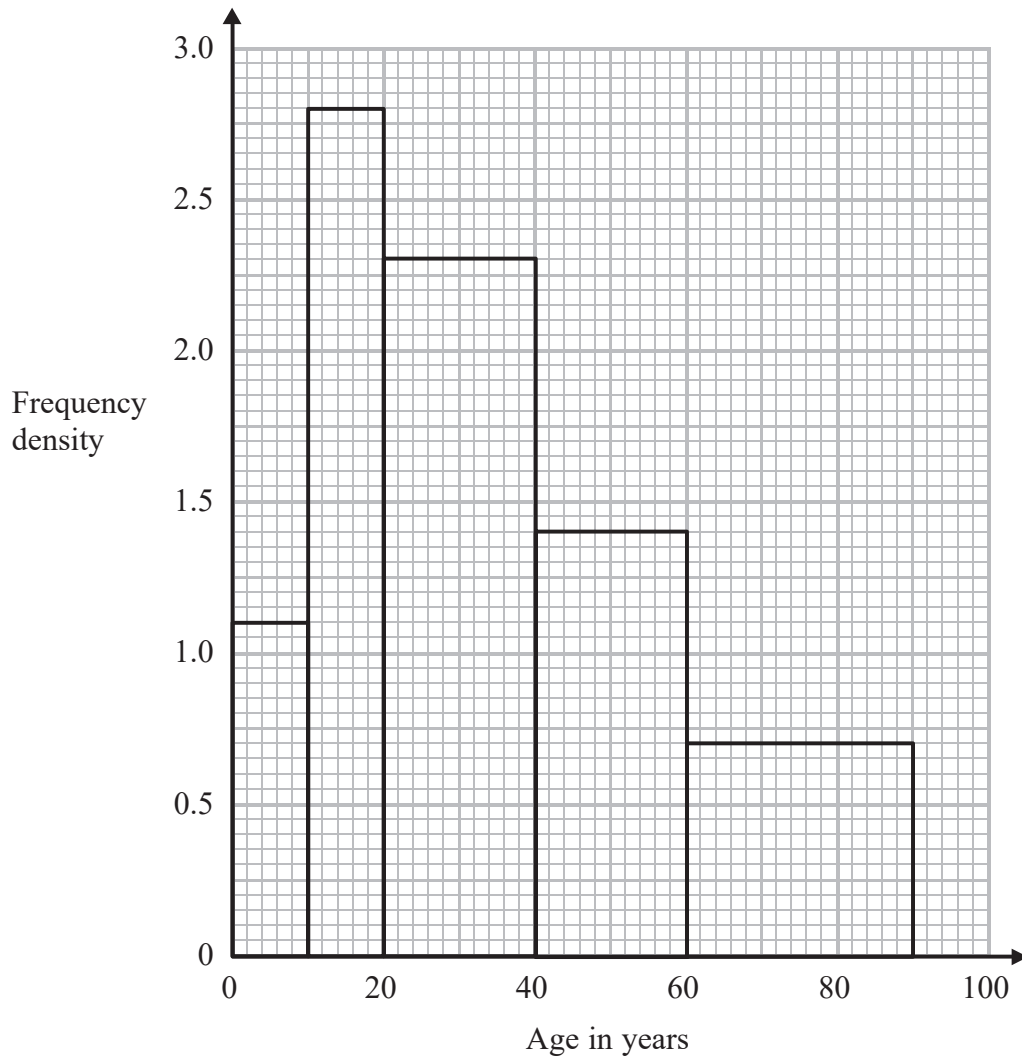

20% of the members of the sports club who are over 50 years of age are female.

Work out an estimate for the number of female members who are over 50 years of age.

(Total for Question 13 is 3 marks)



14 Here are some graphs.

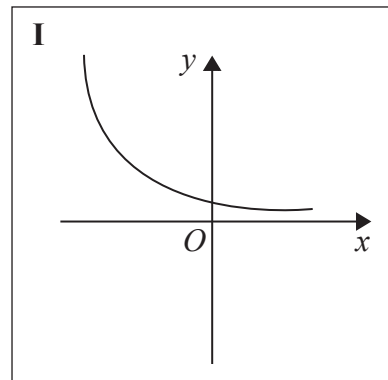
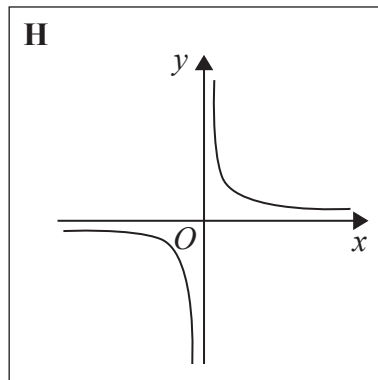
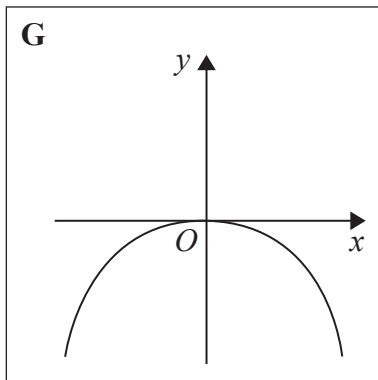
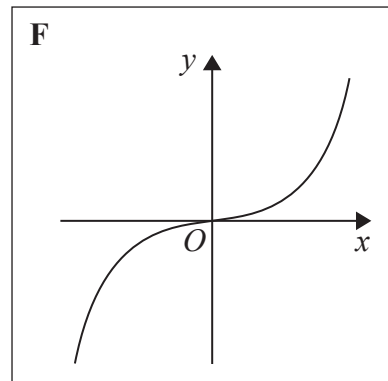
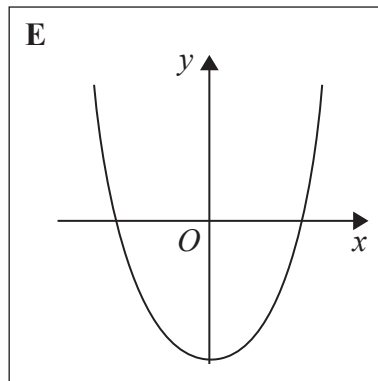
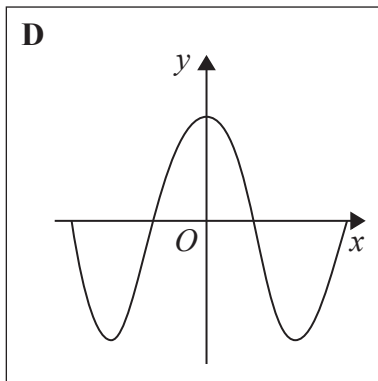
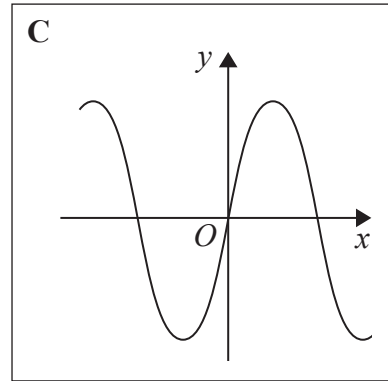
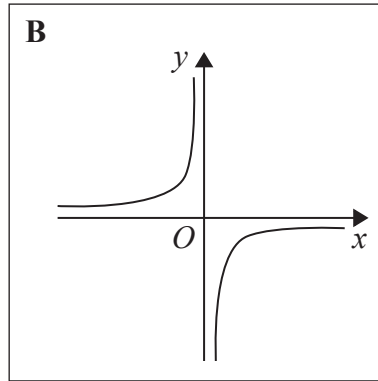
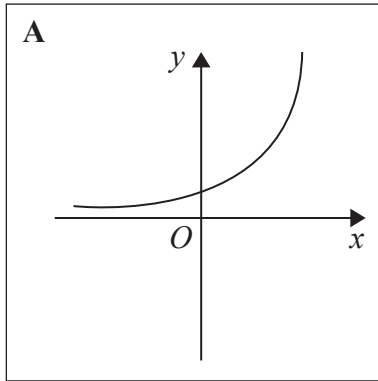

In the table below, match each equation with the letter of its graph.

Equation	Graph
$y = \sin x$	
$y = x^3 + 4x$	
$y = 2^x$	
$y = \frac{4}{x}$	

(Total for Question 14 is 3 marks)

DO NOT WRITE IN THIS AREA

DO NOT WRITE IN THIS AREA

DO NOT WRITE IN THIS AREA



15 A, B, C and D are four points on the circumference of a circle.

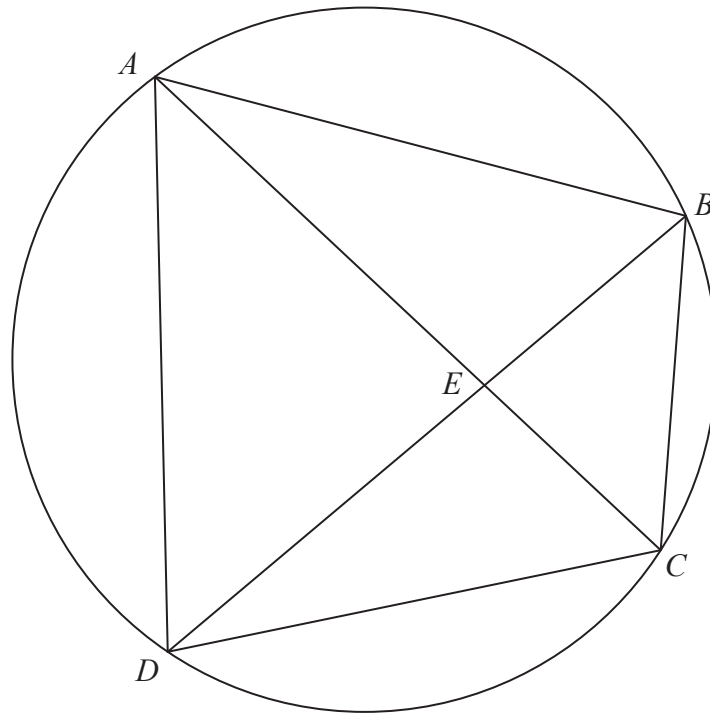

AEC and BED are straight lines.

Prove that triangle ABE and triangle DCE are similar.
You must give reasons for each stage of your working.

(Total for Question 15 is 3 marks)

DO NOT WRITE IN THIS AREA

DO NOT WRITE IN THIS AREA

DO NOT WRITE IN THIS AREA



16 Using algebra, prove that $0.1\dot{3}\dot{6} \times 0.\dot{2}$ is equal in value to $\frac{1}{33}$

(Total for Question 16 is 3 marks)

DO NOT WRITE IN THIS AREA

DO NOT WRITE IN THIS AREA

DO NOT WRITE IN THIS AREA



17

DO NOT WRITE IN THIS AREA

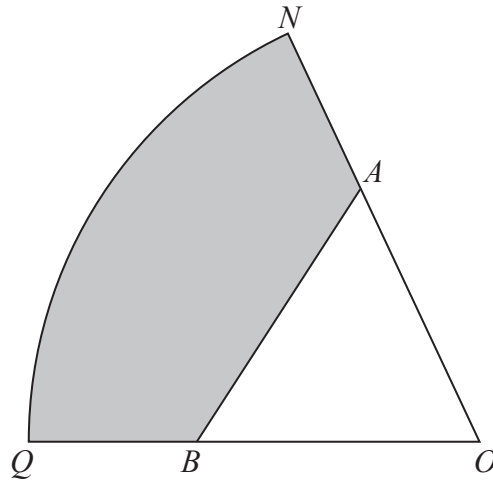

ONQ is a sector of a circle with centre O and radius 11 cm.

A is the point on ON and B is the point on OQ such that AOB is an equilateral triangle of side 7 cm.

Calculate the area of the shaded region as a percentage of the area of the sector ONQ .
Give your answer correct to 1 decimal place.

DO NOT WRITE IN THIS AREA

DO NOT WRITE IN THIS AREA

.....%

(Total for Question 17 is 5 marks)



18 $16^{\frac{1}{5}} \times 2^x = 8^{\frac{3}{4}}$

Work out the exact value of x .

(Total for Question 18 is 3 marks)

DO NOT WRITE IN THIS AREA

DO NOT WRITE IN THIS AREA

DO NOT WRITE IN THIS AREA



19 $2 - \frac{x+2}{x-3} - \frac{x-6}{x+3}$ can be written as a single fraction in the form $\frac{ax+b}{x^2-9}$

where a and b are integers.

Work out the value of a and the value of b .

$$a = \dots\dots\dots$$

$$b = \dots\dots\dots$$

(Total for Question 19 is 4 marks)

DO NOT WRITE IN THIS AREA

DO NOT WRITE IN THIS AREA

DO NOT WRITE IN THIS AREA



20 The diagram shows part of the graph of $y = x^2 - 2x + 3$

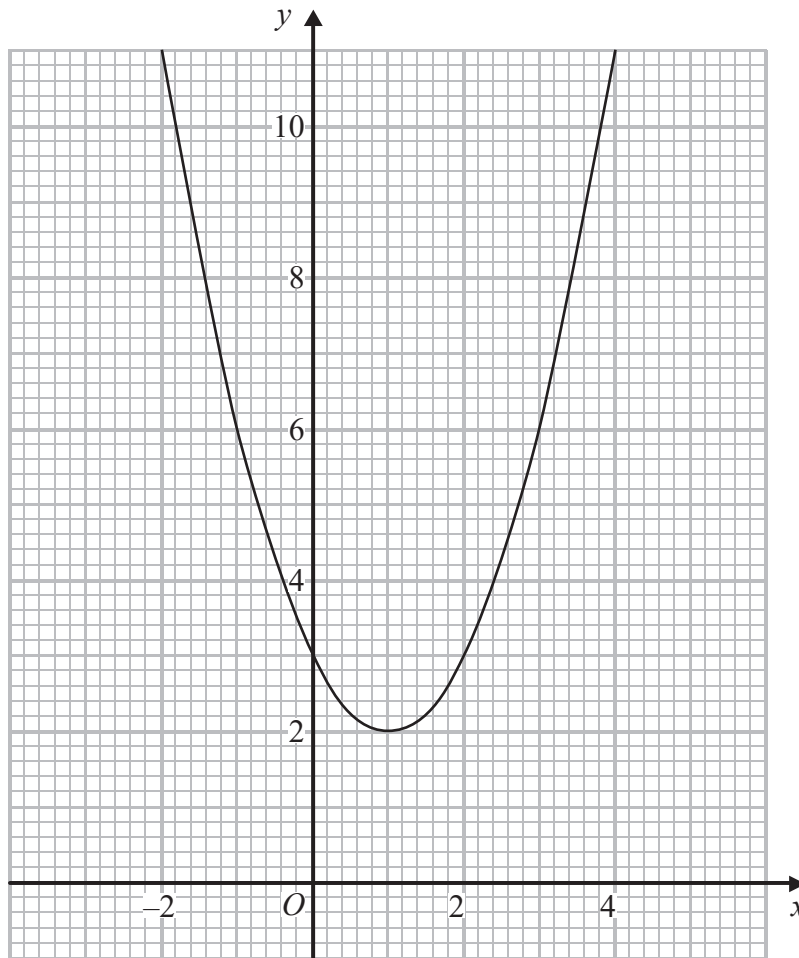

(a) By drawing a suitable straight line, use your graph to find estimates for the solutions of $x^2 - 3x - 1 = 0$

.....
(2)

P is the point on the graph of $y = x^2 - 2x + 3$ where $x = 2$

(b) Calculate an estimate for the gradient of the graph at the point P .

.....
(3)

(Total for Question 20 is 5 marks)

DO NOT WRITE IN THIS AREA

DO NOT WRITE IN THIS AREA

DO NOT WRITE IN THIS AREA



DO NOT WRITE IN THIS AREA

DO NOT WRITE IN THIS AREA

DO NOT WRITE IN THIS AREA

- 21 The diagram shows 3 identical circles inside a rectangle. Each circle touches the other two circles and the sides of the rectangle, as shown in the diagram.

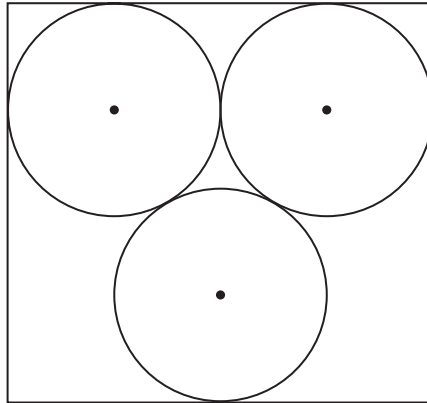

The radius of each circle is 24 mm.

Work out the area of the rectangle.

Give your answer correct to 3 significant figures.

..... mm²

(Total for Question 21 is 4 marks)



22 Here are the first five terms of a sequence.

4 11 22 37 56

Find an expression, in terms of n , for the n th term of this sequence.

.....
(Total for Question 22 is 3 marks)

DO NOT WRITE IN THIS AREA

DO NOT WRITE IN THIS AREA

DO NOT WRITE IN THIS AREA



23 **L** is the circle with equation $x^2 + y^2 = 4$

$P\left(\frac{3}{2}, \frac{\sqrt{7}}{2}\right)$ is a point on **L**.

Find an equation of the tangent to **L** at the point P .

DO NOT WRITE IN THIS AREA

.....
(Total for Question 23 is 3 marks)

TOTAL FOR PAPER IS 80 MARKS



DO NOT WRITE IN THIS AREA

DO NOT WRITE IN THIS AREA

DO NOT WRITE IN THIS AREA

BLANK PAGE

